

- > Ø 32 ... 125 mm
- > High performance, stability and reliability
- > M/50 switches can be mounted flush with the profile
- > Cylinders and mountings conform to ISO 15552 (ISO 6431, VDMA 24562 and NFE 49-003-1)
- > Comprehensive range of mountings
- > Polyurethane seals ensure efficient low friction operation and long life

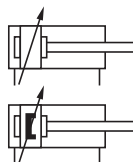

Technical features

Medium:

Compressed air, filtered, lubricated or non-lubricated

Standard:

ISO 15552

Operation:

PRA/182000: Double acting, adjustable cushioning
PRA/182000/M: Double acting, adjustable cushioning and magnetic piston

Operating pressure:

1 ... 16 bar (14 ... 232 psi)

Ports:

G1/8 ... G1/2

Cylinder diameters:

32, 40, 50, 63, 80, 100, 125 mm

Strokes:

See page below

Non-standard strokes:

Available (10 ... 3000 mm)

Operating temperature:

-20 ... +80°C max. (-4 ... +176 °F)

Air supply must be dry enough to avoid ice formation at temperatures below +2°C (+35°F).

Materials:

Profile barrel: anodised aluminium, End covers: pressure diecast aluminium
Piston rod: stainless steel (martensitic)
Piston rod seals: PUR
Piston seals: PUR
O-rings: NBR





Technical data

Cylinder Ø (mm)	32	40	50	63	80	100	125
Port size	G1/8	G1/4	G1/4	G3/8	G3/8	G1/2	G1/2
Piston rod Ø (mm)	12	16	20	20	25	25	32
Piston rod thread	M10 x 1,25	M12 x 1,25	M16 x 1,5	M16 x 1,5	M20 x 1,5	M20 x 1,5	M27 x 2
Cushion length (mm)	19	22	24	24	27	34	41
Initial cushion volume (cm ³)	12,3	20,7	36	64	116	242	451
Theoretical thrusts at 6 bar outstroke (N)	482	754	1178	1870	3016	4710	7363
Theoretical thrusts at 6 bar instroke (N)	414	633	990	1680	2722	4416	6882
Air consumption at 6 bar outstroke (l/cm)	0,056	0,088	0,137	0,218	0,35	0,55	0,86
Air consumption at 6 bar instroke (l/cm)	0,048	0,074	0,114	0,195	0,32	0,51	0,79

Standard strokes

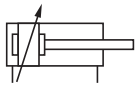
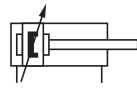
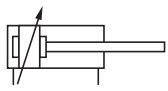
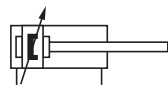
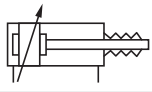
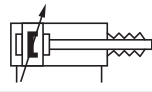
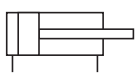
Cylinder Ø (mm)	Stroke length (mm)										
	25	50	80	100	125	160	200	250	320	400	500
32	•	•	•	•	•	•	•	•	•	•	•
40	•	•	•	•	•	•	•	•	•	•	•
50	•	•	•	•	•	•	•	•	•	•	•
63	•	•	•	•	•	•	•	•	•	•	•
80	•	•	•	•	•	•	•	•	•	•	•
100	•	•	•	•	•	•	•	•	•	•	•
125	•	•	•	•	•	•	•	•	•	•	•

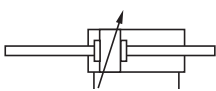
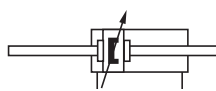
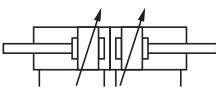
Cylinder variants

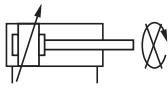
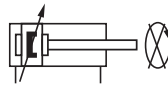
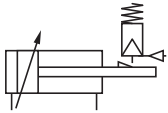
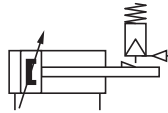
Symbol	Model Non-magnetic piston				Symbol	Model magnetic piston				Description	Dimensions Page		
	H	T	C	S		H	T	C	S				
	•	•	•	•	RA/182000		•	•	•	RA/182000/M	Standard cylinder	6	
				•	RA/182000/W1		•	•	•	RA/182000/W2	Cylinder with special wiper/seal (suitable for appl. with cement, plaster (stucco), arizona sand, hoar-frost or ice (Ø 32 ... 125 mm))	6	
			•	•	RA/182000/X1				•	•	RA/182000/X2	Low friction cylinders, operating pressure: 1 ... 10 bar Medium: Compressed air, filtered and non-lubricated recommended (Ø 32 ... 200 mm)	6
					PRA/182000/IL						PRA/182000/MIL	Cylinder barrel turned at 90° for use with guide blocks QA/8000/51, .../61, .../81 & .../85	6
	•	•	•	•	RA/182000/IU		•	•	•	•	RA/182000/MU	Cylinder with extended piston rod	6
				•	RA/182000/W5		•	•	•	•	RA/182000/W6	Cylinder with extended piston rod and special wiper/seal (suitable for applications with cement, plaster (stucco), arizona sand, hoar-frost or ice (Ø 32 ... 125 mm))	6
		•	•	•	RA/182000/G			•	•	•	RA/182000/MG	Cylinder with piston rod bellows	8
	•	•	•	•	RA/182000/W		•	•	•	•	RA/182000/MW	Cylinder without cushioning	6
				•	RA/182000/X3				•	•	RA/182000/X4	Low friction cylinders without cushioning, operating pressure: 1 ... 10 bar Medium: Compressed air, filtered and non-lubricated recommended (Ø 32 ... 200 mm)	6
	•	•	•	•	RA/182000/J		•	•	•	•	RA/182000/JM	Cylinder with double ended piston rod	7
				•	RA/182000/W3				•	•	RA/182000/W4	Cylinder with double ended piston rod and special wiper/seal (suitable for applications with cement, plaster (stucco), arizona sand, hoar-frost or ice (Ø 32 ... 125 mm))	7
		•			RA/182000/IT			•			RA/182000/MT	Four position cylinders (Ø 32 ... 200 mm)	7
					RA/182000/N1						RA/182000/N2	Cylinder with non-rotating piston rod, (Ø 32 ... 100 mm)	6
		•	•		RA/182000/L2			•	•		RA/182000/L4	Cylinder with locking unit (passive) spring force on removal of the signal to the unit. Operating pressure for locking unit: 4 ... 10 bar (Ø 32 ... 125 mm)	8

For the cylinder models style H*1), T, C and S see options selector

*1) Cylinder style H (Hydraulic version): Ø 32 ... 100 mm only

Option selector
★P★A/182★/★/★/★/★

Non-standard variants	Substitute
High temperature version 150°C max.	T
Hydraulic version ø 32 ... 100 mm only	H
Piston rod material	Substitute
Stainless steel martensitic	R
Hard chromium plated	C
Stainless steel austenitic	S
Cylinder Ø	Substitute
032, 040, 050, 063, 080, 100, 125	
Variants (magnetic piston)	Substitute
Standard	M
Special wiper/seal	W2
Low friction	X2
Piston rod bellow	MG
Without cushion	MW
Without cushion, low friction	X4
Double ended piston rod	JM
Double ended piston rod special wiper/seal	W4
Four-position cylinder	MT
Non-rotating piston rod (internal)	N2
Locking unit (passive)	L4
Barrel turned at 90° (for use with guideblocks QA/8000/51 and .../61)	MIL
Extended piston rod	MU
Extended piston rod, special wiper/seal	W6
P★A/182★/MU/★/★/★/★ /W6/	→ Extension (mm)

Strokes (mm)	Substitute
3000 max.	
Variants (non-magnetic piston)	Substitute
Standard	None
Special wiper/seal	W1
Low friction	X1
Piston rod bellow	G
Without cushion	W
Without cushion, low friction	X3
Double ended piston rod	J
Double ended piston rod special wiper/seal	W3
Four-position cylinder	IT
Non-rotating piston rod (internal)	N1
Locking unit (passive)	L2
Barrel turned at 90° (for use with guideblocks QA/8000/51 and .../61)	IIL
Extended piston rod	IU
Extended piston rod special wiper/seal P★/182★/IU/★/★/★/★ /W5/	→ Extension (mm)

Note: If option is not required, disregard option position within part number eg. PRA/182100/M/100.

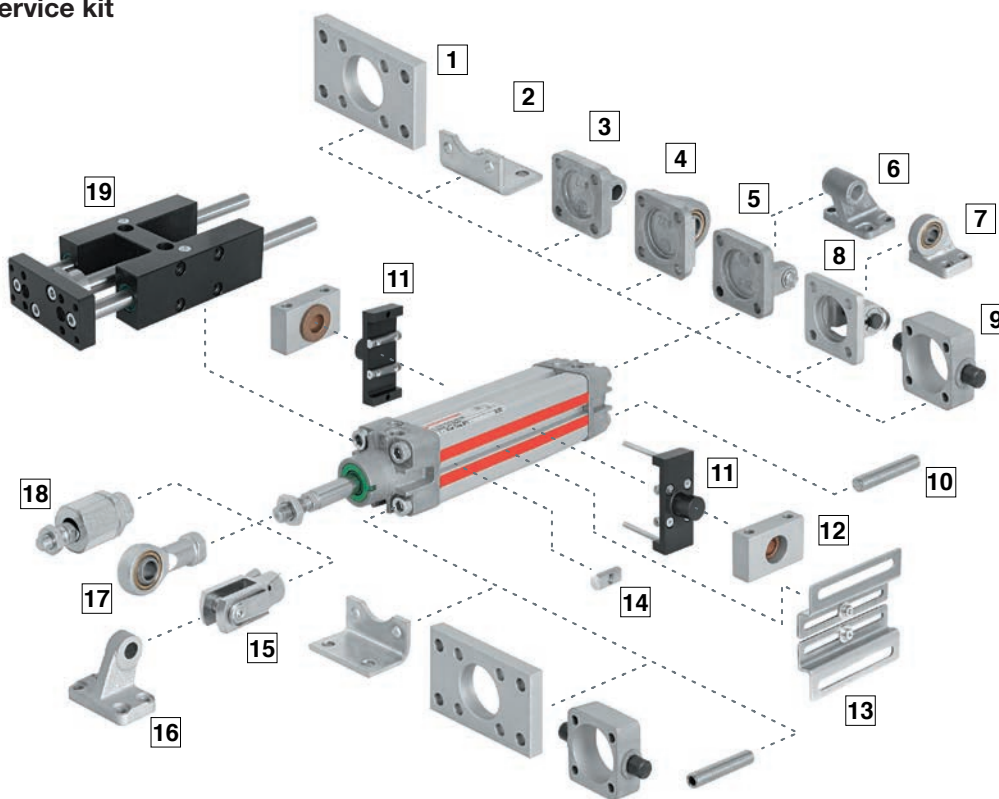

For combinations of cylinder variants consult our technical service. Please note that heat resistant seals are not available for all variants. This options selector explains only the cylinder variants. Additional variants/options are not possible.

Mountings and service kit





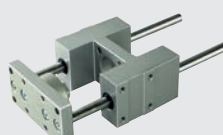
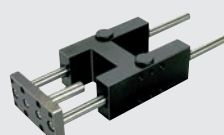

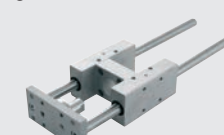











Position	Style	Standard	Position	Style	Standard
1	B, G	Clear anodised aluminium	10	A	Galvanized steel
2	C	Galvanized steel (ø 32 ... 63 mm), Painted steel (ø 80 & 100 mm)	11	UH	Black anodised aluminium bar stock Groove key and bolt: Galvanized steel
3	R	Die-cast aluminium	12	S	Clear anodised aluminium Bearing: brass
4	UR	Galvanized aluminium Inner ring: steel Outer ring: brass	13	Valve mounting kit	Galvanized steel
5	D	Die-cast aluminium Bolt: galvanized steel (martensitic) Circlip: galvanized steel	15	F	Galvanized steel Bolt: galvanized steel Circlip: Galvanized steel
6	SW	Die-cast aluminium	16	SS	Painted cast iron
7	US	Galvanized aluminium. Inner ring: steel Outer ring: brass	17	UF	Galvanized steel. Inner ring: steel Outer ring: brass
8	D2	Painted cast iron. Bolt: stainless steel (martensitic) Circlip: galvanized steel	18	AK	Galvanized steel
9	FH	Cast iron			

Guide blocks





	Guide blocks - plain bearings	Guide blocks - roller bearings	Guide blocks - plain bearings, long coupling	Guide blocks - plain bearings, short coupling
				
Cyl. Ø	19	19	19	19
	Page 13	Page 14	Page 16	Page 16
32	QA/8032/51/*	QA/8032/61/*	QA/8032/81/*	QA/8032/85/*
40	QA/8040/51/*	QA/8040/61/*	QA/8040/81/*	QA/8040/85/*
50	QA/8050/51/*	QA/8050/61/*	QA/8050/81/*	QA/8050/85/*
63	QA/8063/51/*	QA/8063/61/*	QA/8063/81/*	QA/8063/85/*
80	QA/8080/51/*	QA/8080/61/*	QA/8080/81/*	QA/8080/85/*
100	QA/8100/51/*	QA/8100/61/*	QA/8100/81/*	QA/8100/85/*

* Insert standard stroke length: 50, 100, 160, 200, 250, 320, 400 and 500 mm, use nearest standard stroke.

Mountings

Model	A	AK	B, G	C	D	D2	F	FH
								
Cyl. Ø	10 Page 9	18 Page 9	1 Page 9	2 Page 9	5 Page 9	8 Page 9	15 Page 10	9 Page 10
32	QM/8032/35	QM/8025/38	QA/8032/22	QA/8032/21	QA/8032/23	QA/8032/42	QM/8025/25	QA/8032/34
40	QM/8032/35	QM/8040/38	QA/8040/22	QA/8040/21	QA/8040/23	QA/8040/42	QM/8040/25	QA/8040/34
50	QM/8050/35	QM/8050/38	QA/8050/22	QA/8050/21	QA/8050/23	QA/8050/42	QM/8050/25	QA/8050/34
63	QM/8050/35	QM/8050/38	QA/8063/22	QA/8063/21	QA/8063/23	QA/8063/42	QM/8050/25	QA/8063/34
80	QM/8080/35	QM/8080/38	QA/8080/22	QA/8080/21	QA/8080/23	QA/8080/42	QM/8080/25	QA/8080/34
100	QM/8080/35	QM/8080/38	QA/8100/22	QA/8100/21	QA/8100/23	QA/8100/42	QM/8080/25	QA/8100/34
125	QM/8125/35	QM/8125/38	QM/8125/22	QM/8125/21	QM/8125/23	QA/8125/42	QM/8125/25	QA/8125/34
	R	S	SS	SW	UF	UH	UR	US
								
Cyl. Ø	3 Page 10	12 Page 10	16 Page 11	6 Page 11	17 Page 10	11 Page 10	4 Page 11	7 Page 12
32	QA/8032/27	QA/8032/41	M/P19931	M/P19493	QM/8025/32	PQA/182032/40	QA/8032/33	M/P40310
40	QA/8040/27	QA/8040/41	M/P19932	M/P19494	QM/8040/32	PQA/182040/40	QA/8040/33	M/P40311
50	QA/8050/27	QA/8040/41	M/P19933	M/P19495	QM/8050/32	PQA/182050/40	QA/8050/33	M/P40312
63	QA/8063/27	QA/8063/41	M/P19934	M/P19496	QM/8050/32	PQA/182063/40	QA/8063/33	M/P40313
80	QA/8080/27	QA/8063/41	M/P19935	M/P19497	QM/8080/32	PQA/182080/40	QA/8080/33	M/P40314
100	QA/8100/27	QA/8100/41	M/P19936	M/P19498	QM/8080/32	PQA/182100/40	QA/8100/33	M/P40315
125	QM/8125/27	QA/8100/41	M/P19937	M/P19499	QM/8125/32	PQA/182125/40	QM/8125/33	M/P71355

Accessories

	Groove cover	M/50/**	Groove key	Valve mounting kit
				
Cyl. Ø	Page 12	Page 18 & 19	14 Page 12	13 Page 12
32	M/P72725/1000		M/P72816	–
40	M/P72725/1000		M/P72816	–
50	M/P72725/1000		M/P72816	QA/180050/22/54
63	M/P72725/1000		M/P72816	QA/180050/22/54
80	M/P72725/1000		M/P72816	QA/180080/22/54
100	M/P72725/1000		M/P72816	QA/180080/22/54
125	M/P72725/1000		M/P72816	QA/180080/22/54

Service kit

	Groove cover
	
Cyl. Ø	
32	QA/8032/00
40	QA/8040/00
50	QA/8050/00
63	QA/8063/00
80	QA/8080/00
100	QA/8100/00
125	QA/8125/00

Basic dimensions

PRA/182000; PRA/182000/M – Standard cylinder

Dimensions in mm
Projection/First angle

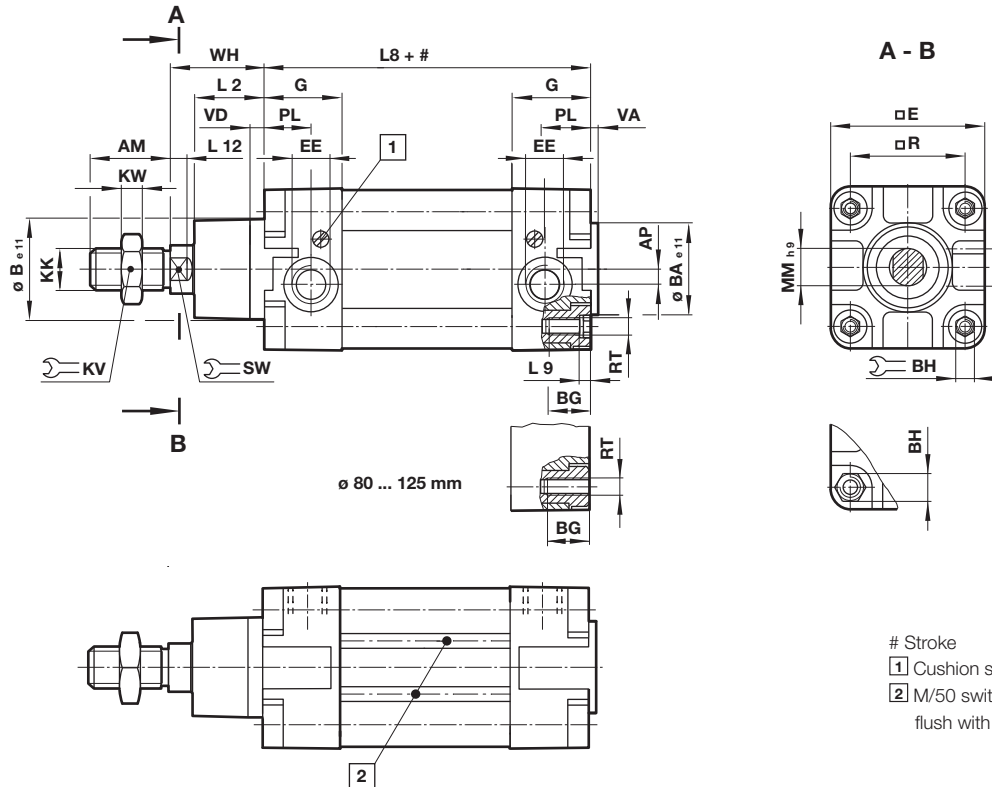

- # Stroke
- 1 Cushion screw
- 2 M/50 switches can be mounted flush with the profile

Ø	AM	AP	Ø B e11	Ø BA e11	BG	BH	E	EE	G	KK	KV	KW	L2	L8	L9
32	22	3,5	30	30	16	6	47	G 1/8	27,5	M10x1,25	17	5	20	94	4
40	24	4,5	35	35	16	6	53	G 1/4	32	M12x1,25	19	6	22	105	4
50	32	6	40	40	16	8	65	G 1/4	31	M16x1,5	24	8	27	106	5
63	32	10	45	45	16	8	75	G 3/8	33	M16x1,5	24	8	29	121	5
80	40	8,5	45	45	17	19	95	G 3/8	33	M20x1,5	30	10	33	128	-
100	40	9	55	55	17	19	115	G 1/2	37	M20x1,5	30	10	36	138	-
125	54	10	60	60	20	24	140	G 1/2	46	M27x2	41	13,5	45	160	-
Ø	L12	Ø MM h9	PL	R	RT	SW	VA	VD	WH	at 0 mm	per 25 mm	Model non-magnetic piston	Model magnetic piston		
32	6	12	13	32,5	M 6	10	3	6	26	0,51 kg	0,06 kg	PRA/182032/*	PRA/182032/M/*		
40	6,5	16	15	38	M 6	13	3,5	6	30	0,80 kg	0,08 kg	PRA/182040/*	PRA/182040/M/*		
50	8	20	18,5	46,5	M 8	17	3,5	6	37	1,33 kg	0,12 kg	PRA/182050/*	PRA/182050/M/*		
63	8	20	19	56,5	M 8	17	4	6	37	1,80 kg	0,13 kg	PRA/182063/*	PRA/182063/M/*		
80	10	25	19	72	M 10	22	4	6	46	3,25 kg	0,20 kg	PRA/182080/*	PRA/182080/M/*		
100	10	25	18	89	M 10	22	4	6	51	4,81 kg	0,23 kg	PRA/182100/*	PRA/182100/M/*		
125	13	32	20	110	M 12	27	6	15,5	65	8,00 kg	0,33 kg	PRA/182125/*	PRA/182125/M/*		

* Please insert standard stroke length.

Cylinder variants

PRA/182000/N1, PRA/182000/N2 – Cylinder with non-rotating piston rod

Ø	max. Torque (Nm)	Model non-magnetic piston	Model magnetic piston
32	10	0,5	PRA/182032/N1/* PRA/182032/N2/*
40	13	1	PRA/182040/N1/* PRA/182040/N2/*
50	16	1,5	PRA/182050/N1/* PRA/182050/N2/*
63	16	1,5	PRA/182063/N1/* PRA/182063/N2/*
80	16	2,5	PRA/182080/N1/* PRA/182080/N2/*
100	21	2,5	PRA/182100/N1/* PRA/182100/N2/*

* Please insert standard stroke length.

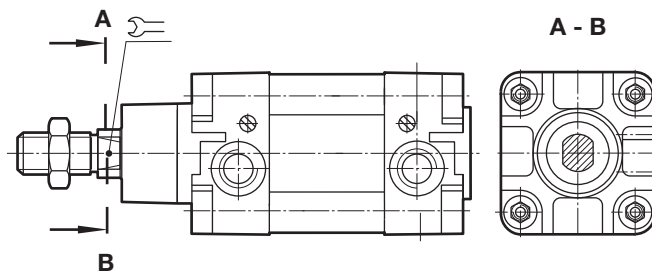

Cylinder variants
PRA/182000/J, PRA/182000/JM – Cylinder with double ended piston rod

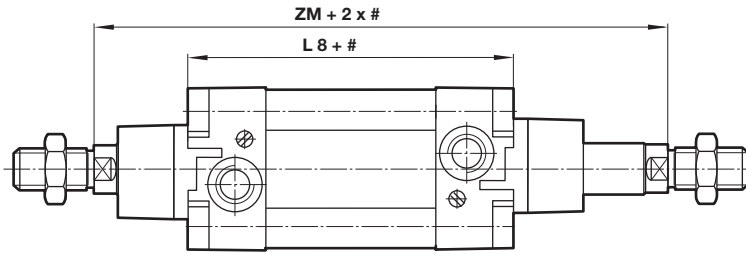
 Dimensions in mm
Projection/First angle

Stroke

Ø	ZM	L8	Model non-magnetic piston	Model magnetic piston
32	146	94	PRA/182032/J/*	PRA/182032/JM/*
40	165	105	PRA/182040/J/*	PRA/182040/JM/*
50	180	106	PRA/182050/J/*	PRA/182050/JM/*
63	195	121	PRA/182063/J/*	PRA/182063/JM/*
80	220	128	PRA/182080/J/*	PRA/182080/JM/*
100	240	138	PRA/182100/J/*	PRA/182100/JM/*
125	290	160	PRA/182125/J/*	PRA/182125/JM/*

* Please insert standard stroke length.

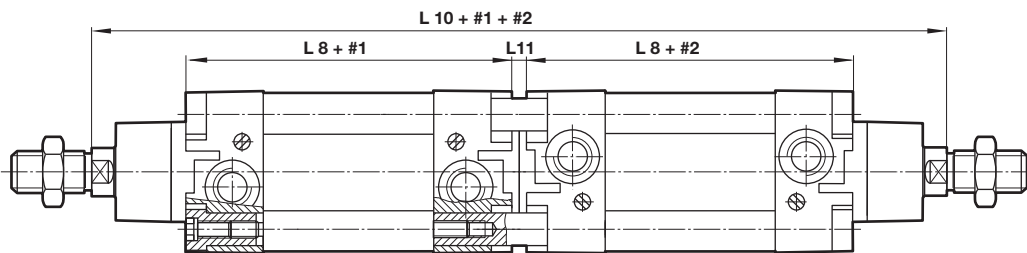
PRA/182000/IT, PRA/182000/MT – Four-position cylinder

Stroke length 1 and stroke length 2

Ø	L 8	L 10	L 11	Model non-magnetic piston	Model magnetic piston
32	94	247	7	PRA/182032/IT/*/**	PRA/182032/MT/*/**
40	105	278	8	PRA/182040/IT/*/**	PRA/182040/MT/*/**
50	106	294	8	PRA/182050/IT/*/**	PRA/182050/MT/*/**
63	121	325	9	PRA/182063/IT/*/**	PRA/182063/MT/*/**
80	128	357	9	PRA/182080/IT/*/**	PRA/182080/MT/*/**
100	138	387	9	PRA/182100/IT/*/**	PRA/182100/MT/*/**
125	160	462	12	PRA/182125/IT/*/**	PRA/182125/MT/*/**

* Please insert standard stroke length 1

** Please insert standard stroke length 2

PRA/182000/G, PRA/182000/MG – Piston rod bellow

Dimensions in mm
Projection/First angle

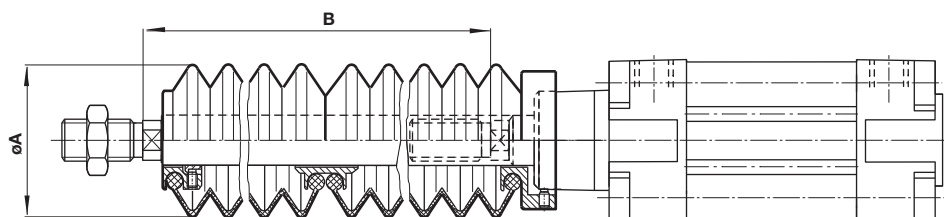

Ø	Ø A	Max. stroke per bellow	Piston rod extension B		Model non-magnetic piston	Model magnetic piston
			for first bellow	for further bellow		
32	40	60	30	25	PRA/182032/G/*	PRA/182032/MG/*
40	63	145	50	32	PRA/182040/G/*	PRA/182040/MG/*
50	63	145	40	32	PRA/182050/G/*	PRA/182050/MG/*
63	63	145	40	32	PRA/182063/G/*	PRA/182063/MG/*
80	80	250	50	45	PRA/182080/G/*	PRA/182080/MG/*
100	80	250	50	45	PRA/182100/G/*	PRA/182100/MG/*
125	80	250	50	45	PRA/182125/G/*	PRA/182125/MG/*

* Please insert standard stroke length.

PRA/182000/L2, PRA/182000/L4 – Cylinder with locking unit (passive)

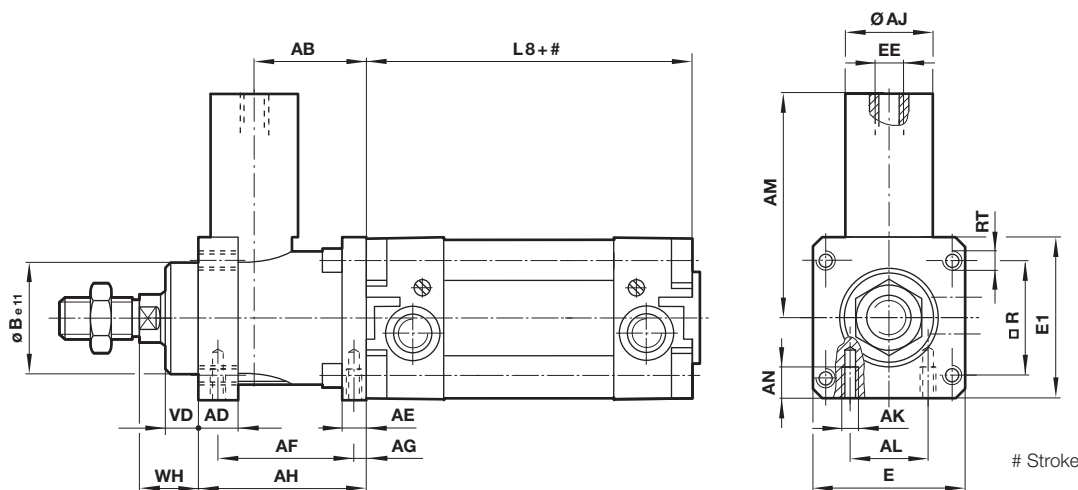

Ø	AB	AD	AE	AF	AG	AH	Ø AJ	AK	AL	AM	AN	Ø B e11	E	E 1	EE
32	32	12	8	40	4,2	48	25	M 5	16	59	8	30	48	50	M 5
40	35,5	12	10	46	4,5	55	24	M 5	21	61,5	10	35	56	58	G 1/8
50	49	16	15	54	11,5	70	30	M 6	24	75	12	40	68	70	G 1/8
63	49	15	15	55	7,5	70	38	M 8	32	86	12	45	82	85	G 1/8
80	62	16	16	70	10	90	53	M 8	44	119	16	45	100	105	G 1/8
100	65	18	16	70	10	92	48	M 8	60	119	16	55	120	130	G 1/8
125	85	27	25	95	11	122	65	M 10	75	140	20	60	140	150	G 1/8
Ø	L 8	□ R	RT	VD	WH	Locking force (N)	Spare part Locking unit *1)	Spare part Cartridge	Model Non-magnetic piston	Model Magnetic piston					
32	94	32,5	M 6	10	16	600	QA/8032/59	QA/8032/63	PRA/182032/L2/*	PRA/182032/L4/*					
40	105	38	M 6	10	18	1000	QA/8040/59	QA/8040/63	PRA/182040/L2/*	PRA/182040/L4/*					
50	106	46,5	M 8	12	22	1500	QA/8050/59	QA/8050/63	PRA/182050/L2/*	PRA/182050/L4/*					
63	121	56,5	M 8	12	20	2200	QA/8063/59	QA/8063/63	PRA/182063/L2/*	PRA/182063/L4/*					
80	128	72	M 10	20	33	5000	QA/8080/59	QA/8100/63	PRA/182080/L2/*	PRA/182080/L4/*					
100	138	89	M 10	23	38	5000	QA/8100/59	QA/8100/63	PRA/182100/L2/*	PRA/182100/L4/*					
125	160	110	M 12	32	65	7000	QA/8125/59	QA/8125/63	PRA/182125/L2/*	PRA/182125/L4/*					

* Please insert standard stroke length.

*1) With cartridge

Mountings

Front or rear stud mounting A

Conforms to ISO 15552, type MX1

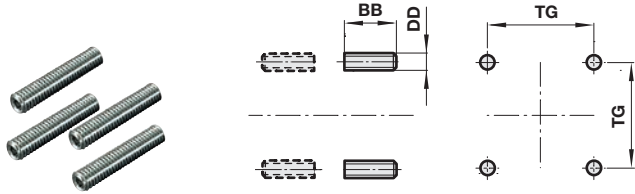

Ø	BB	DD	TG	kg	Model (A)
32/40	17	M6	32,5/38	0,02	QM/8032/35
50/63	23	M8	46,5/56,5	0,05	QM/8050/35
80/100	28	M10	72/89	0,08	QM/8080/35
125	34	M12	110	0,14	QM/8125/35

Front flange B, G

Conforms to ISO 15552, type MF1 and MF2

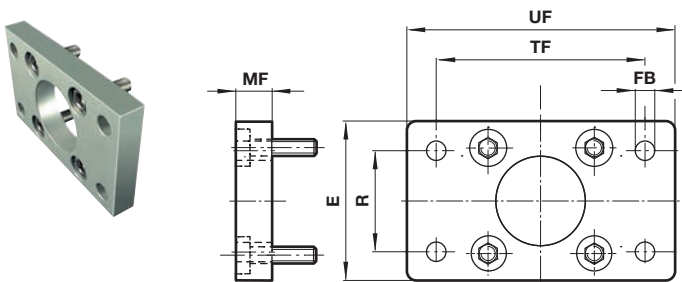

Ø	E	Ø FB	MF	R	TF	UF	kg	Model (B, G)
32	50	7	10	32	64	80	0,25	QA/8032/22
40	55	9	10	36	72	90	0,35	QA/8040/22
50	65	9	12	45	90	110	0,70	QA/8050/22
63	75	9	12	50	100	125	0,80	QA/8063/22
80	100	12	16	63	126	154	1,35	QA/8080/22
100	120	14	16	75	150	186	2,20	QA/8100/22
125	140	16	20	90	180	224	2,70	QM/8125/22

Rear clevis D

Conforms to ISO 15552, type MP2

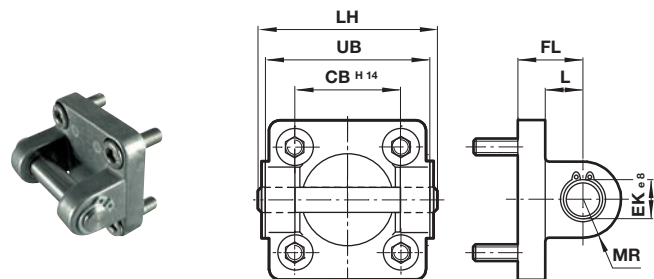

Ø	CB H14	Ø EK e8	FL	L	LH	MR	UB	kg	Model (D)
32	26	10	22	13	52	9	45	0,11	QA/8032/23
40	28	12	25	16	60	12	52	0,16	QA/8040/23
50	32	12	27	17	68	12	60	0,22	QA/8050/23
63	40	16	32	22	79	15	70	0,34	QA/8063/23
80	50	16	36	22	99	15	90	0,54	QA/8080/23
100	60	20	41	27	119	20	110	0,90	QA/8100/23
125	70	25	50	31	139	25	130	2,70	QM/8125/23

Piston rod swivel AK

Dimensions in mm
Projection/First angle

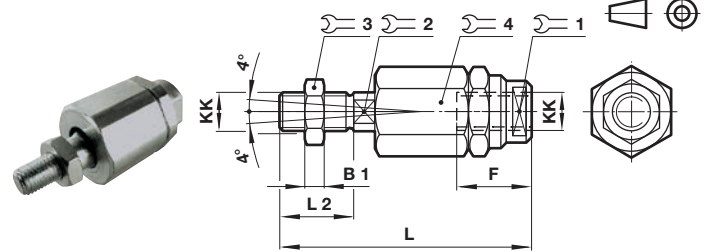

Ø	KK	B1	F	L	L2	1 2 3 4				kg	Model (AK)
						1	2	3	4		
32	M10x1,25	5	26	73	20	19	12	17	30	0,20	QM/8025/38
40	M12x1,25	6	26	77	24	19	12	19	30	0,20	QM/8040/38
50/63	M16x1,5	8	34	106	32	30	19	24	42	0,65	QM/8050/38
80/100	M20x1,5	10	42	122	40	30	19	30	42	0,72	QM/8080/38
125	M27x2	13,5	40	147	54	40	24	41	55	1,70	QM/8125/38

Foot mounting C

Conforms to ISO 15552, type MS1

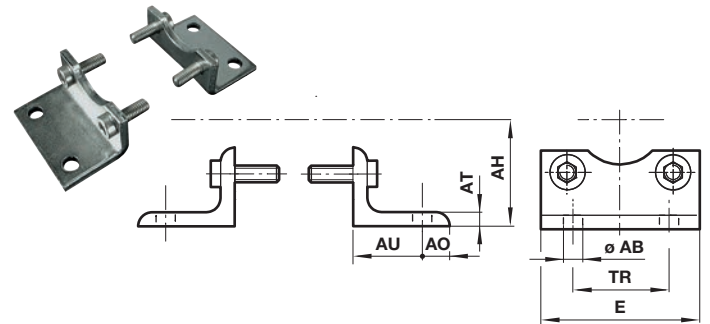

Ø	Ø AB	AH	AO	AT	AU	E	TR	kg	Model (C)
32	7	32	8	4	24	48	32	0,15	QA/8032/21
40	10	36	9	4	28	53	36	0,18	QA/8040/21
50	10	45	10	5	32	64	45	0,30	QA/8050/21
63	10	50	12	5	32	74	50	0,39	QA/8063/21
80	12	63	19	5	41	98	63	0,80	QA/8080/21
100	14	71	19	5	41	115	75	0,95	QA/8100/21
125	16	90	20	9	45	140	90	2,40	QM/8125/21

Rear clevis D2

Conforms to ISO 15552, type AB6

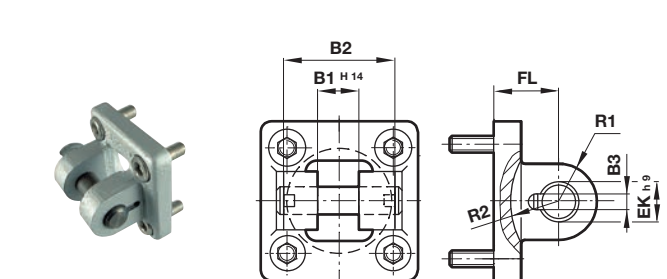

Ø	B1 H14	B2	B3	Ø EK h9	FL	R1	R2	kg	Model (D2)
32	14	34	3,3	10	22	11	17	0,20	QA/8032/42
40	16	40	4,3	12	25	12	20	0,23	QA/8040/42
50	21	45	4,3	16	27	14,5	22	0,36	QA/8050/42
63	21	51	4,3	16	32	18	25	0,55	QA/8063/42
80	25	65	4,3	20	36	22	30	0,90	QA/8080/42
100	25	75	4,3	20	41	22	32	1,45	QA/8100/42
125	37	97	6,3	30	50	30	42	2,7	QA/8125/42

Piston rod clevis F
Conforms to DIN ISO 8140

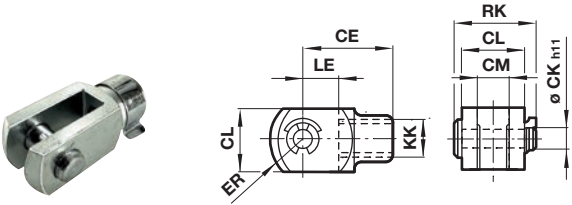

Ø	KK	CE	Ø CK h11	CL	CM	ER	LE	RK	kg	Model (F)
32	M10x1,25	40	10	20	10	16	20	28	0,09	QM/8025/25
40	M12x1,25	48	12	24	12	19	24	32	0,13	QM/8040/25
50/63	M16x1,5	64	16	32	16	25	32	41,5	0,33	QM/8050/25
80/100	M20x1,5	80	20	40	20	32	40	50	0,67	QM/8080/25
125	M27x2	110	30	55	30	45	54	62	1,35	QM/8125/25

Rear eye R
Conforms to ISO 15552, type MP4

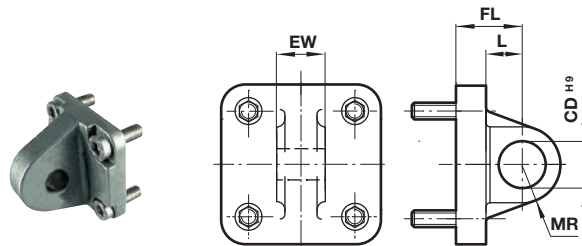

Ø	Ø CD H9	EW	FL	L	MR	kg	Model (R)
32	10	25,8	22	13	9	0,09	QA/8032/27
40	12	27,8	25	16	12	0,11	QA/8040/27
50	12	31,7	27	17	12	0,17	QA/8050/27
63	16	39,7	32	22	15	0,24	QA/8063/27
80	16	49,7	36	22	15	0,37	QA/8080/27
100	20	59,7	41	27	20	0,59	QA/8100/27
125	25	69,7	50	33	25	3,20	QM/8125/27

Universal piston rod eye UF
Conforms to DIN ISO 8139

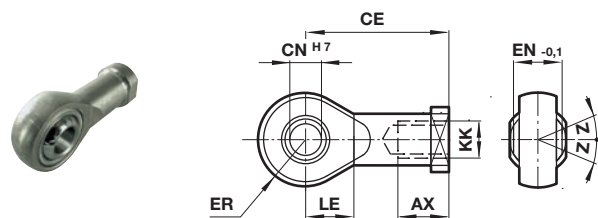

Ø	Thread KK	AX	CE	Ø CN H7	EN -0,1	ER	LE	Z	kg	Model (UF)
32	M10x1,25	20	43	10	14	14	15	13°	0,09	QM/8025/32
40	M12x1,25	22	50	12	16	16	17	13°	0,13	QM/8040/32
50/63	M16x1,5	28	64	16	21	21	22	15°	0,33	QM/8050/32
80/100	M20x1,5	33	77	20	25	25	26	15°	0,67	QM/8080/32
125	M27x2	51	110	30	37	35	36	15°	1,35	QM/8125/32

Front or rear detachable trunnion FH
Conforms to VDMA 24562 part 2,
type MT 5/6

Dimensions in mm
Projection/First angle

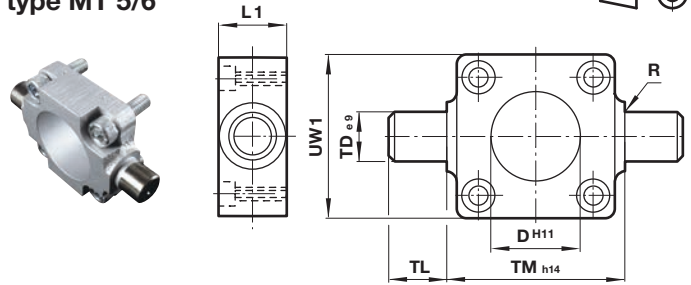

Ø	Ø D h11	L1	R	Ø TD e9	TL	TM h14	UW1	kg	Model (FH)
32	30	16	1	12	12	50	45	0,20	QA/8032/34
40	35	20	1,6	16	16	63	55	0,38	QA/8040/34
50	40	24	1,6	16	16	75	65	0,60	QA/8050/34
63	45	24	1,6	20	20	90	75	1,10	QA/8063/34
80	45	28	1,6	20	20	110	100	1,90	QA/8080/34
100	55	38	2	25	25	132	120	3,50	QA/8100/34
125	60	50	2	25	25	160	145	6,50	QA/8125/34

Trunnion support S
Conforms to ISO 15552, type AT4

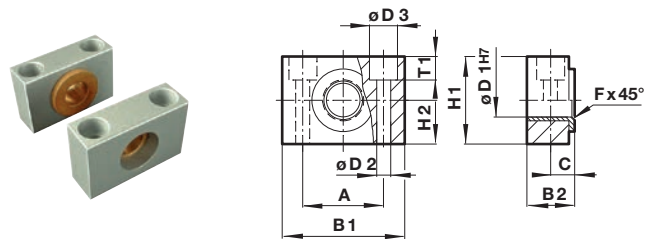

Ø	A	B	C	Ø D1 H7	Ø D2	Ø D3	Fx 45°	H	T1	kg	Model (S)		
32	32	46	18	10,5	12	6,6	11	1	30	15	6,8	0,10	QA/8032/41
40/50	36	55	21	12	16	9	15	1,6	36	18	9	0,14	QA/8040/41
63/80	42	65	23	13	20	11	18	1,6	40	20	11	0,18	QA/8063/41
100/125	50	75	28,5	16	25	14	20	2	50	25	13	0,34	QA/8100/41

Adjustable trunnion mounting UH
Conforms to ISO 15552, type MT4

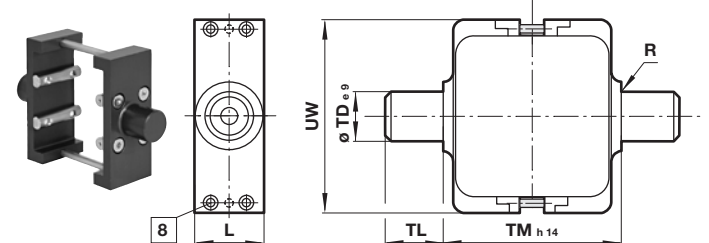

8 Locking screws

Ø	L	R	Ø TD e9	TL	TM h14	UW	Torque max. (Nm)	kg	Model (UH)
32	25	1	12	12	50	58	2	0,16	PQA/182032/40
40	28	1,6	16	16	63	65	3,5	0,35	PQA/182040/40
50	28	1,6	16	16	75	80	3,5	0,65	PQA/182050/40
63	36	1,6	20	20	90	96	5	0,85	PQA/182063/40
80	36	1,6	20	20	110	116	6	1,2	PQA/182080/40
100	48	2	25	25	132	140	6	2,3	PQA/182100/40
125	48	2	25	25	160	163	6	3,3	PQA/182125/40

Style 'UH': It is most important that the locking screws which secure the mounting to the tie rod are tightened to the torque figures shown in the table below. For maximum energy input, consult our Technical Service.

**Universal rear eye UR
Conforms to ISO 15552, type MP6**

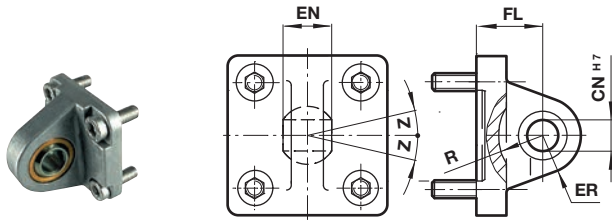
 Dimensions in mm
Projection/First angle

Ø	Ø CN H7	EN	ER	FL	R	Z	kg	Model (UR)
32	10	14	16	22	14,5	13°	0,15	QA/8032/33
40	12	16	18	25	18	13°	0,25	QA/8040/33
50	16	21	21	27	19	15°	0,40	QA/8050/33
63	16	21	23	32	24	15°	0,55	QA/8063/33
80	20	25	28	36	24	15°	0,90	QA/8080/33
100	20	25	30	41	29	15°	1,50	QA/8100/33
125	30	37	40	50	36	15°	2,70	QM/8125/33

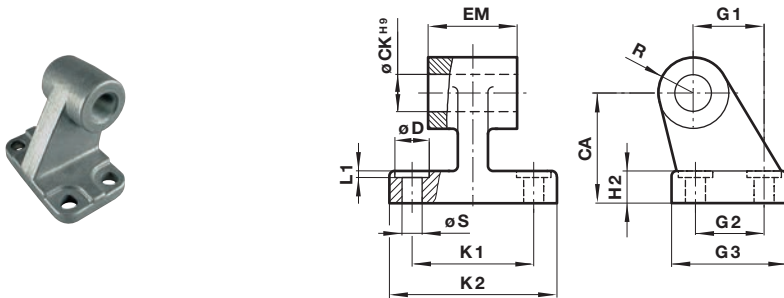
**Wide hinge SW
Conforms to ISO 15552, type AB7**

Ø	CA	Ø CK H9	Ø D	H2	EM	G1	G2	G3	K1	K2	L1	R	Ø S	kg	Model (SW)
32	32	10	11	7	25,5	21	18	31	38	50	1,6	10	6,6	0,05	M/P19493
40	36	12	11	9	27,5	24	22	35	41	54	1,6	11	6,6	0,07	M/P19494
50	45	12	15	11	31,5	33	30	45	50	65	1,6	13	9	0,14	M/P19495
63	50	16	15	12	39,5	37	35	50	52	67	1,6	15	9	0,18	M/P19496
80	63	16	18	14	49,5	47	40	60	66	84	2,5	15	11	0,28	M/P19497
100	71	20	18	15	59,5	55	50	70	76	94	2,5	19	11	0,42	M/P19498
125	90	25	20	20	70,5	70	60	90	94	124	3,2	22	14	2,70	M/P19499

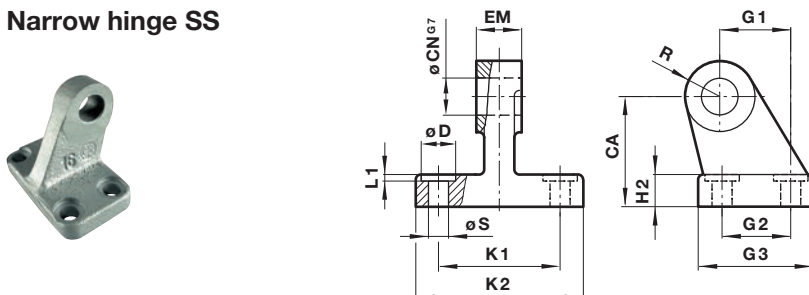
Narrow hinge SS

Ø	CA	Ø CN G7	Ø D	H2	EM	G1	G2	G3	K1	K2	L1	R	Ø S	kg	Model (SS)
32	32	10	11	8	10	21	18	31	38	51	1,6	10	6,6	0,15	M/P19931
40	36	12	11	10	12	24	22	35	41	54	1,6	11	6,6	0,20	M/P19932
50	45	16	15	12	16	33	30	45	50	65	1,6	13	9	0,48	M/P19933
63	50	16	15	12	16	37	35	50	52	67	1,6	15	9	0,50	M/P19934
80	63	20	18	14	20	47	40	60	66	86	2,5	15	11	0,75	M/P19935
100	71	20	18	15	20	55	50	70	76	96	2,5	19	11	1,20	M/P19936
125	90	25	20	20	30	70	60	90	94	124	3,2	22	14	2,50	M/P19937

Swivel hinge US
Conforms to VDMA 24562 part 2

Dimensions in mm
Projection/First angle

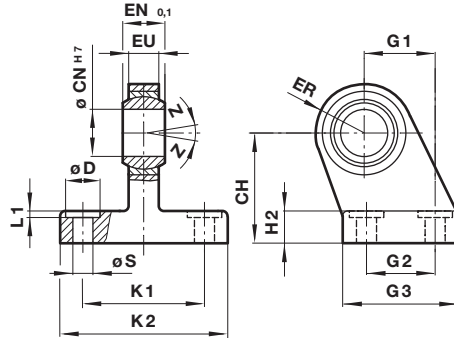

Ø	CH	Ø CN H7	Ø D	EN -0,1	ER	EU	G1	G2	G3	H2	K1	K2	L1	Ø S	Z	kg	Model (US)
32	32	10	11	14	16	10,5	21	18	31	10	38	51	1,6	6,6	13°	0,19	MP40310
40	36	12	11	16	18	12	24	22	35	10	41	54	1,6	6,6	13°	0,24	MP40311
50	45	16	15	21	21	15	33	30	45	12	50	65	1,6	9	13°	0,46	MP40312
63	50	16	15	21	23	15	37	35	50	12	52	67	1,6	9	15°	0,59	MP40313
80	63	20	18	25	28	18	47	40	60	14	66	86	2,5	11	15°	1,03	MP40314
100	71	20	18	25	30	18	55	50	70	15	76	96	2,5	11	15°	1,40	MP40315
125	90	30	20	37	40	25	70	60	90	20	94	124	3,2	14	15°	3,10	MP71355

Groove key M/P72816
Weight: 0,01 kg

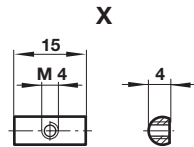

Valve mounting kit

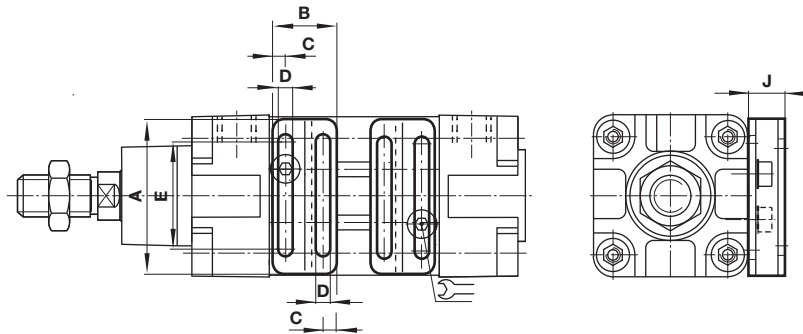

Ø	A	B	C	D	E	F	G	H	J	kg	Model	
50/63	60	37	7	4,5	46	8,5	5,5	2	12	3	0,02	QA/180050/22/54
80/100/125	90	37	7	4,5	76	8,5	6,5	2	12	3	0,02	QA/180080/22/54

Groove cover M/P72725/1000

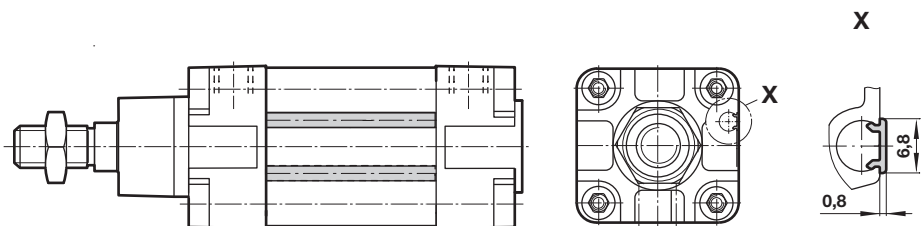

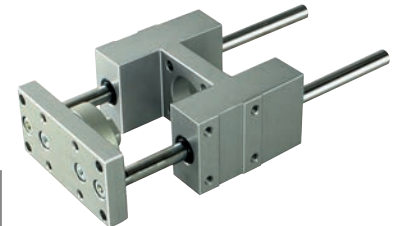
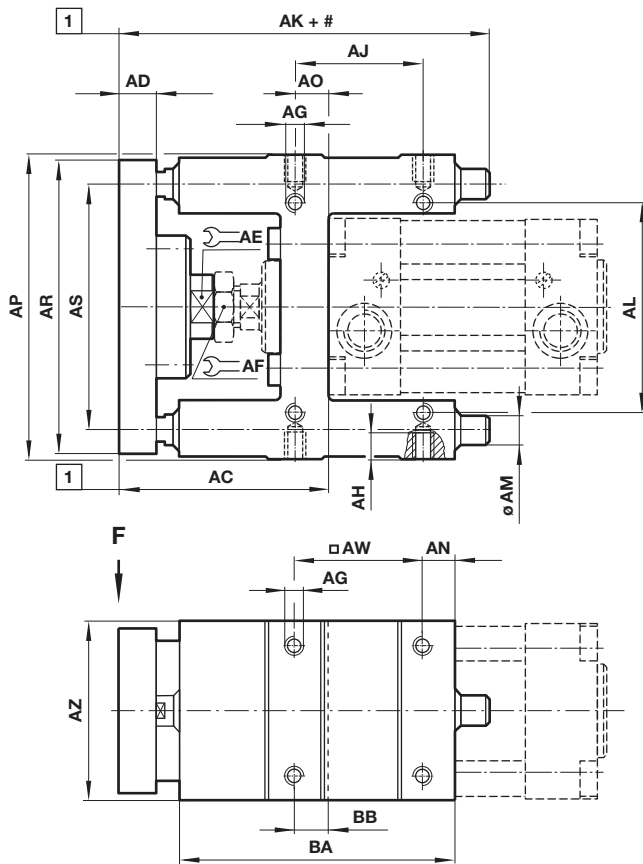
QA/8000/51 – Guide blocks (plain bearings)

Dimensions in mm
Projection/First angle



Stroke
 1 Adjustment range
 $\phi 32$ & $40 = +2$
 $\phi 50$ & $63 = +4$
 $\phi 80$ & $100 = +6$

ϕ	AC	AD	ϕAE	ϕAF	AG	AH	AJ	AK	AL	ϕAM	AN	AO	AP
32	69	12	15	17	M 6	10	32,5	110	58	10	6	9	100
40	74	12	15	19	M 6	10	38	122	64	12	6	11	106
50	91,5	15	22	24	M 8	12	46,5	135	80	12	6	19	125
63	92	15	22	24	M 8	12	56,5	153	95	12	7	15	132
80	106	15	27	30	M 10	15	50	180	130	16	9	14	165
100	111	15	27	30	M 10	17	70	199	150	16	9	19	185
ϕ	AR	AS	AT	AV	$\square AW$	ϕAX	AZ	BA	BB	kg at 0 mm	kg per 100 mm	Model	
32	90	74	78	45	32,5	6,6	48	76	9	1,0	0,06	QA/8032/51/*	
40	100	80	84	50	38	6,6	56	85	11	1,2	0,09	QA/8040/51/*	
50	120	96	100	60	46,5	9	66	99	19	1,8	0,09	QA/8050/51/*	
63	125	104	105	70	56,5	9	76	114	15	2,2	0,09	QA/8063/51/*	
80	155	130	130	90	72	11	98	134,5	25	4,1	0,16	QA/8080/51/*	
100	175	150	150	110	89	11	118	153,5	28,5	5,8	0,16	QA/8100/51/*	

* Insert standard stroke length: 50, 100, 160, 200, 250, 320, 400 and 500 mm, use nearest standard stroke.
 Note: Supplied complete with mounting screws for cylinders

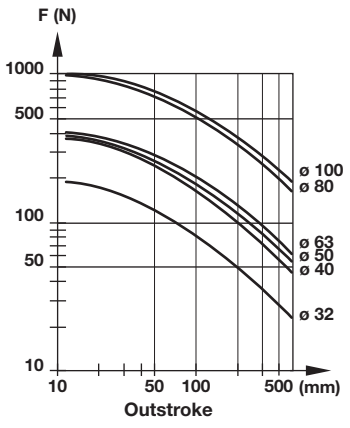
Maximum load

QA/8000/61 – Guide blocks (roller bearings)

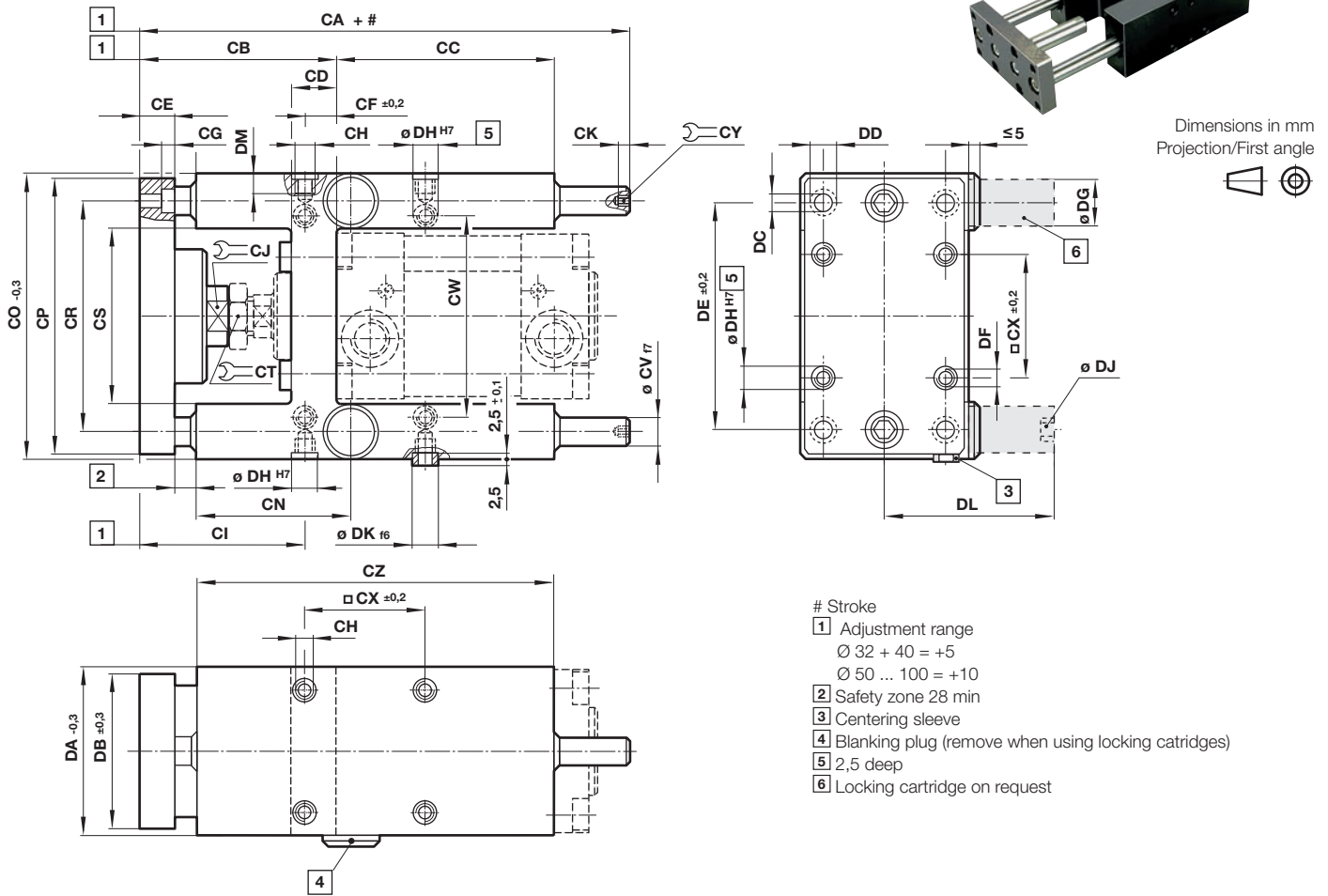

Ø	CA	CB	CC	CD	CE	CF ±0,2	CG	CH	CI	CJ	CK	CN	CO -0,3
32	177	100	65	28	12	15,3	6,5	M 6	84,5	13	5	61	97
40	192	111	69	33	12	23	6,5	M 6	88	15	6	67	115
50	237	128	65	40	15	33,8	9	M 8	94	22	6	75,5	137
63	237	128	97	40	15	29,3	9	M 8	98,5	22	6	80	152
80	280	151	112	50	20	37	11	M 10	114	27	7	92	189
100	280	156	112	55	20	40,5	11	M 10	115,5	27	7	93	213
Ø	CP	CR	CS	CT	ØCV F7	CW	CX ±0,2	CY	CZ	DA -0,3	DB ±0,3	DC	Ø DD
32	90	74	50,5	17	12	61	32,5	5	125	50	45	6,6	11
40	110	87	58,5	19	16	69	38	6	140	58	54	6,6	11
50	130	104	70,5	24	20	85	46,5	6	150	70	63	9	15
63	145	119	85,5	24	20	100	56,5	6	182	85	80	9	15
80	180	148	105,5	30	25	130	72	8	215	105	100	11	18
100	200	172	130,5	30	25	150	89	8	220	130	120	11	18
Ø	DE ±0,2	DF	Ø DG	Ø DH H7	DJ	Ø DK f6	DL	DM	kg at 0 mm	kg per 100 mm	Locking force (N)	Cartridge *1)	Model
32	78	M 6	20	9	M 5	9	45	14	1,2	0,18	600	QA/8032/63	QA/8032/61/*
40	84	M 6	24	9	G 1/8	9	61,5	14	2,2	0,32	1000	QA/8040/63	QA/8040/61/*
50	100	M 8	30	11	G 1/8	11	76,5	16	3,6	0,49	1500	QA/8050/63	QA/8050/61/*
63	105	M 8	30	11	G 1/8	11	76,5	16	4,6	0,49	1500	QA/8050/63	QA/8063/61/*
80	130	M 10	48	13	G 1/8	13	119	20	8,7	0,77	3000	QA/8080/63	QA/8080/61/*
100	150	M 10	48	13	G 1/8	13	119	20	11	0,77	3000	QA/8080/63	QA/8100/61/*

* Insert standard stroke length: 50, 100, 160, 200, 250, 320, 400 and 500 mm, use nearest standard stroke.

Note: Supplied complete with mounting screws for cylinders

*1) Locking cartridges should be ordered separately. Passive - pressure to unlock. Two required per guide block.

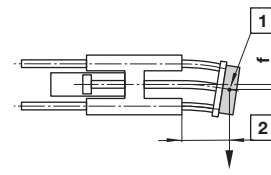
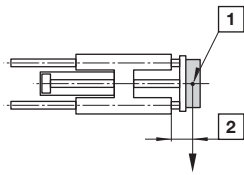
Maximum load for QA/8000/61

 Dimensions in mm
Projection/First angle

- 1 Centre of gravity load capacity
- 2 Outstroke

Maximum load capacity is dependent on the outstroke of a horizontally installed guide unit. In the case of short stroke operation, the load capacity figures taken from the diagram must be multiplied by the correction factor (diagram 2). In the curves of load capacity (diagram 1), the short stroke corrections have already been taken into account for an outstroke > 60 mm.

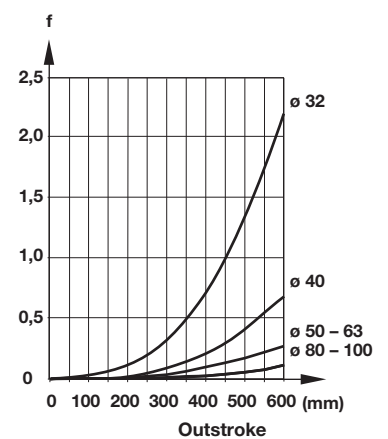
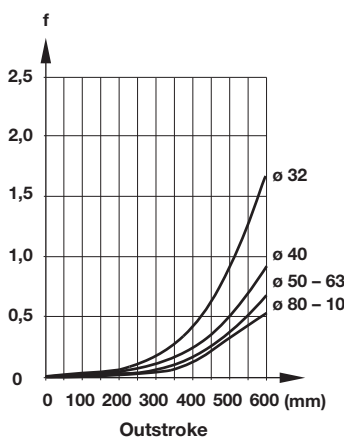
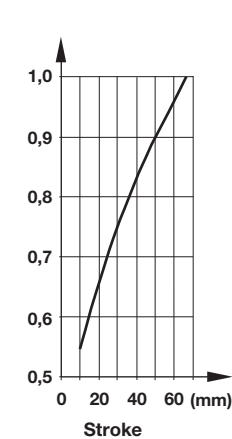
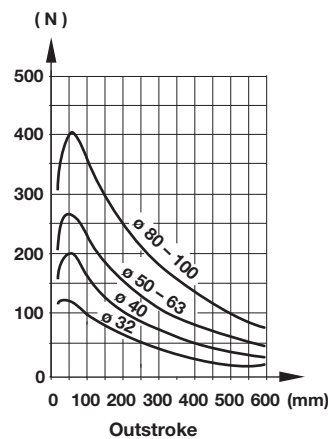
The total deflection of guide rods will be determined by the addition of that due to own weight (diagram 3) and that due to load capacity (diagram 4).

Maximum load capacity depending on outstroke (diagram 1)
Correction factor (diagram 2)
Deflection caused by own weight (diagram 3)
Deflection caused by a load of 10 N (diagram 4)
Load capacity
Correction factor
Deflection (mm)
Deflection (mm)

In the case of shock load applications, the figures given in the diagrams above must be reduced by a factor of 2

QA/8000/81 – Guide blocks (long coupling)
QA/8000/85 – Guide blocks (short coupling)

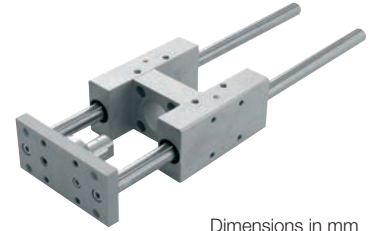
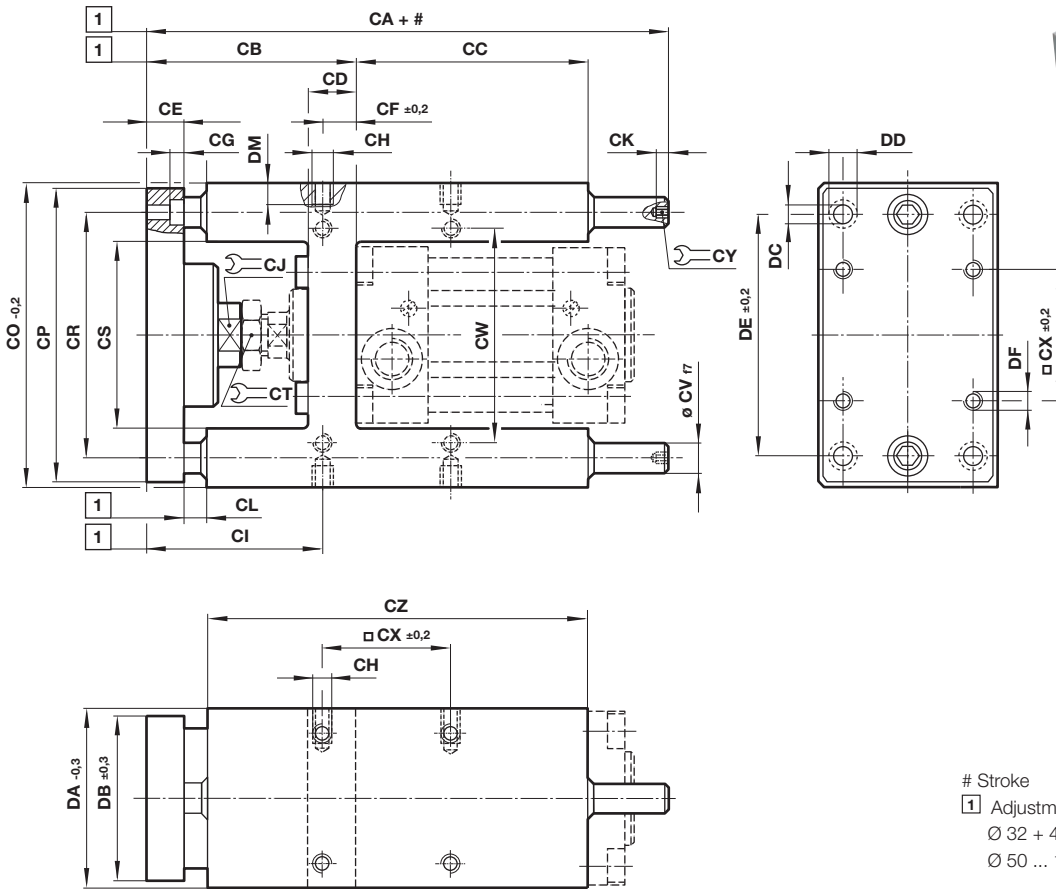

Dimensions in mm
Projection/First angle



Stroke
1 Adjustment range
Ø 32 + 40 = +5
Ø 50 ... 100 = +10

Ø	CA /81	CA /85	CB + /81	CB + /85	CC	CD	CE	CF ±0,2	CG	CH	CI /81	CI /85	CJ
32	174	149	89	64	75	24	12	4,3	6,5	M 6	84,7	59,7	15
40	189	164	99	74	80	28	12	11	6,5	M 6	88	63	15
50	210	181	113	88	78	34	15	18,8	8,5	M 8	94,2	69,2	20
63	235	210	114	89	106	34	15	15,3	9	M 8	98,7	73,7	20
80	265	240	139	114	111	50	20	25	11	M 10	114	89	26
100	288	265	145	120	128	55	20	30	11	M 10	115	90	26
Ø	CK	CL /81	CL /85	CO ±0,2	CP	CR	CS	CT	ØCV r8	CW	CX ±0,2	CY	CZ
32	5	27	2	97	93	74	51	17	12	61	32,5	5	125
40	6	27	2	115	112	87	58,2	19	16	69	38	6	140
50	6	28	3	137	134	104	70,2	24	20	85	46,5	6	148
63	6	27	2	152	147	119	85,2	24	20	100	56,5	6	178
80	7	35	10	189	180	148	105,5	30	25	130	72	8	195
100	7	35	10	213	206	173	130,5	30	25	150	89	8	218
Ø	DA ±0,2	DB ±0,3	Ø DC	Ø DD	DE ±0,2	DF	DM	kg /81 at 0 mm	kg /85 at 0 mm	kg /81; /85 per 100 mm	Model /81	Model /85	
32	49	45	6,6	11	78	M 6	12	1,2	1,15	0,18	QA/8032/81	QA/8032/85	
40	58	55	6,6	11	84	M 6	12	2,2	2,15	0,32	QA/8040/81	QA/8040/85	
50	70	65	9	15	100	M 8	16	3,6	3,55	0,49	QA/8050/81	QA/8050/85	
63	85	80	9	15	105	M 8	16	4,6	4,55	0,49	QA/8063/81	QA/8063/85	
80	105	100	11	18	130	M 10	20	8,7	8,65	0,77	QA/8080/81	QA/8080/85	
100	130	120	11	18	150	M 10	20	11	10,95	0,77	QA/8100/81	QA/8100/85	

* Insert standard stroke length: 50, 100, 160, 200, 250, 320, 400 and 500 mm, use nearest standard stroke.
Note: Supplied complete with mounting screws for cylinders

Maximum load for QA/8000/81 and /85

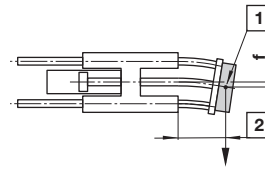
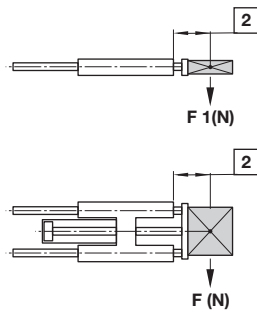
 Dimensions in mm
Projection/First angle

- 1 Centre of gravity load capacity
- 2 Outstroke

$F_1 = F \times 0,9$
Static force: $F_2 = F \times 2$

Max. load capacity (diagram 1) is dependent on the outstroke of a horizontally installed guide unit.

The total deflection of guide rods will be determined by the addition of the amount of deflection caused by own weight (according to diagram 2) plus the amount of deflection due to load capacity (according to diagram 3).

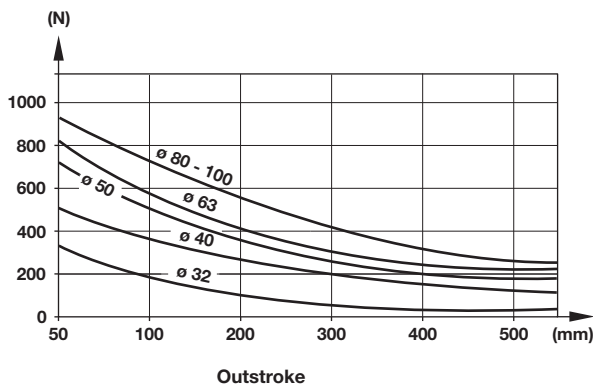
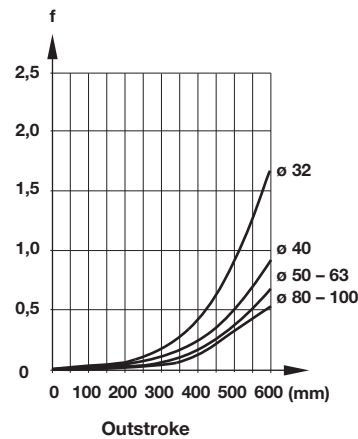
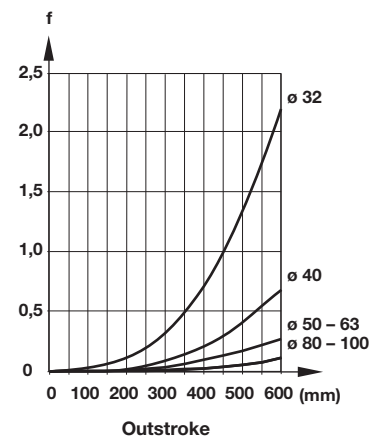
**Maximum load capacity depending on outroke
Deflection caused by a load of 10 N
(diagram 1)**
Load capacity

**Deflection caused by own weight
(diagram 2)
Deflection (mm)**

**Deflection caused by a load of 10 N
(diagram 3)
Deflection (mm)**

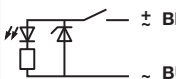
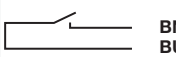
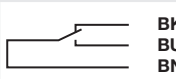
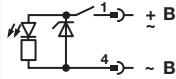
In the case of shock load applications, the figures given in the diagrams above must be reduced by a factor of 2

Technical data - Reed switches - additional informations see data sheet N/en 4.3.005

Symbol	Voltage		Current maximum (mA)	Function	Operating temperature (°C)	LED	Protection class	Plug	Cable length (m)	Cable type	Weight (g)	Model
	(V a.c.)	(V d.c.)										
	10 ... 240	10 ... 170	180	Closer	-25 ... +80	•	IP66	—	2, 5 or 10	PVC 2 x 0,25	37	M/50/LSU/*V
	10 ... 240	10 ... 170	180	Closer	-25 ... +80	•	IP66	—	5	PUR 2 x 0,25	37	M/50/LSU/5U
	10 ... 240	10 ... 170	180	Closer	-25 ... +150	—	IP66	—	2	Silicon 2 x 0,25	37	TM/50/RAU/2S
	10 ... 240	10 ... 170	180	Changeover	-25 ... +80	—	IP66	—	5	PVC 3 x 0,25	37	M/50/RAC/5V
	10 ... 60	10 ... 60	180	Closer	-25 ... +80	•	IP66	M8 x 1	0,3	PVC 3 x 0,25	16	M/50/LSU/CP *1)

* Insert cable length; *1) Plug-in connector see page 11; Color code: BK = black, BN = brown, BU = blue

Drawings

M/50/LSU/*V, M/50/LSU/5U,
TM/50/RAU/2S
Cable length L = 2, 5 or 10 m

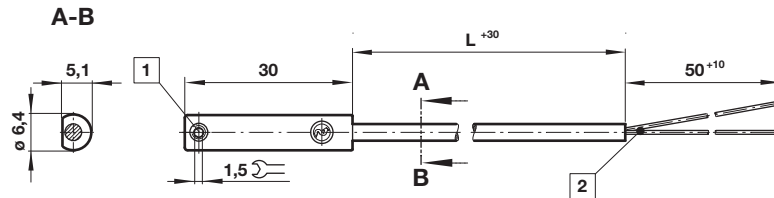

M/50/RAC/5V
Cable length L = 5 m

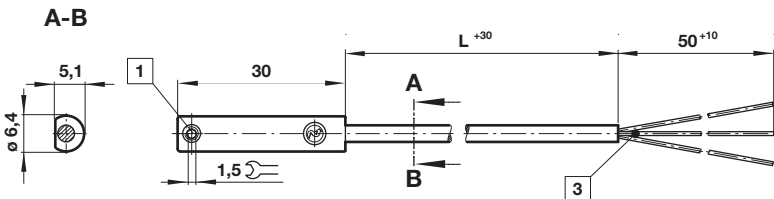

M/50/LSU/CP

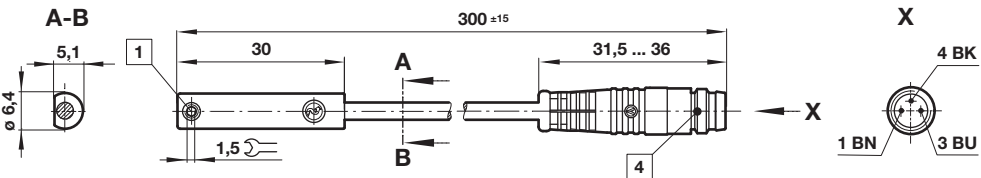

- 1 Fixing screw
- 2 + BN = brown; - BU = blue (output)
- 3 - BK = black; + BN = brown; - BU = blue
- 4 Plug M8 x 1, color code: BK = black; BN = brown; BU = blue

Dimensions in mm
Projection/First angle



Switch mounting brackets - Brackets > 15 mm stroke

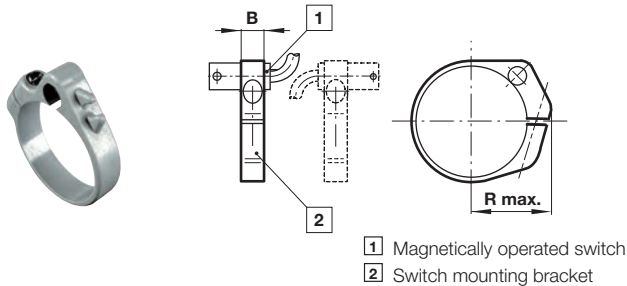

Switch mounting brackets - Brackets < 15 mm stroke

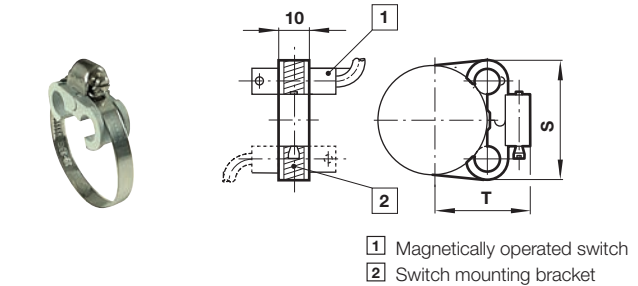

Ø	B	R max.	kg	Model
10	8	16	0,01	QM/33/010/22
12	8	18	0,01	QM/33/012/22
16	10	20	0,01	QM/33/016/22
20	10	22	0,01	QM/33/020/22
25	10	24	0,01	QM/33/025/22

Ø	S	T	kg	Model
10	27,5	19,5	0,01	QM/33/010/23
12	28,5	21,5	0,01	QM/33/016/23
16	29,5	23,5	0,01	QM/33/016/23
20	29,5	26	0,01	QM/33/020/23
25	31,5	28,5	0,01	QM/33/025/23

Technical data - Solid state - additional informations see data sheet N/en 4.3.007

Symbol	Voltage (V d.c.)	Current maximum (mA)	Function	Operating temperature (°C)	LED	Protection class	Plug	Cable length (m)	Cable type	Weight (g)	Model
	10 ... 30	150	PNP	-40 ... +80	•	IP67	—	2, 5 or 10	PVC 3 x 0,12	37	M/50/EAP/*V
	10 ... 30	150	PNP	-40 ... +80	•	IP68	—	5	PUR 3 x 0,14	37	M/50/EAP/5U
	10 ... 30	150	PNP	-40 ... +80	•	IP67	M8 x 1	0,3	PVC 3 x 0,14	16	M/50/EAP/CP *1)
	10 ... 30	150	PNP	-40 ... +80	•	IP67	M12 x 1	0,3	PVC 3 x 0,14	16	M/50/EAP/CC *1)
	10 ... 30	150	NPN	-40 ... +80	•	IP67	—	2, 5 or 10	PVC 3 x 0,12	37	M/50/EAN/*V
	10 ... 30	150	Closer	-40 ... +80	•	IP67	M8 x 1	0,3	PVC 3 x 0,14	16	M/50/EAN/CP *1)

* Insert cable length; *1) Plug-in connector below; Color code: BK = black, BN = brown, BU = blue

Drawings

M/50/EAP/*V,
M/50/EAN/*V
Cable length L = 2, 5 or 10 m

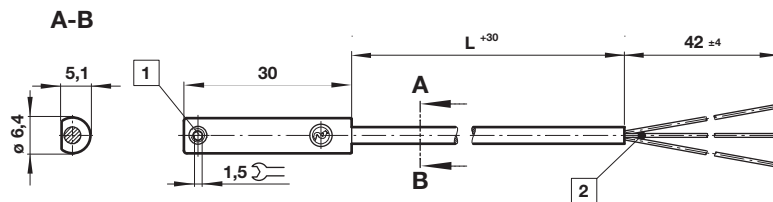

Dimensions in mm
Projection/First angle



M/50/EAP/CP,
M/50/EAN/CP

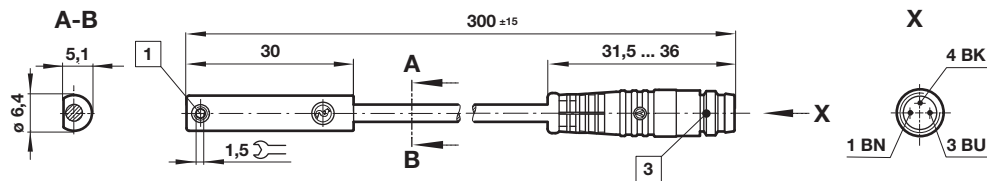

M/50/EAP/CC

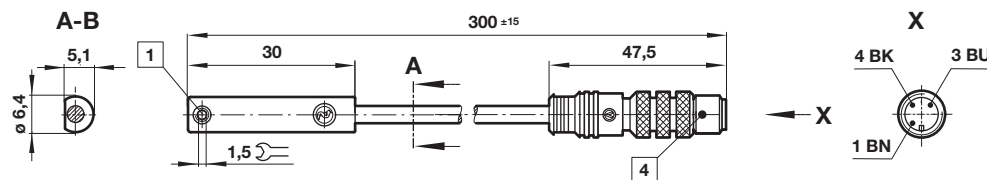

- 1 Fixing screw
- 2 Color code: BK = black; BN = brown; BU = blue
- 3 Plug M8 x 1
- 4 Plug M12 x 1

Accessories

Plug-in connector cable with nut



Outer cover	Cable length (m)	Weight (kg)	Connector	Connector
PVC 3 x 0,25	5 m	0,18	M8 x 1	M/P73001/5
PUR 3 x 0,25	5 m	0,18	M8 x 1	M/P73002/5
PUR 3 x 0,34	5 m	0,21	M12 x 1	M/P34594/5

Warning

These products are intended for use in industrial compressed air systems only. Do not use these products where pressures and temperatures can exceed those listed under

»Technical features/data«.

Before using these products with fluids other than those specified, for non-industrial applications, life-support systems or other applications not within published specifications, consult IMI NORGREN.

Through misuse, age, or malfunction, components used in fluid power systems can fail in various modes.

The system designer is warned to consider the failure modes of all component parts used in fluid power systems and to provide adequate safeguards to prevent personal injury or damage to equipment in the event of such failure.

System designers must provide a warning to end users in the system instructional manual if protection against a failure mode cannot be adequately provided.

System designers and end users are cautioned to review specific warnings found in instruction sheets packed and shipped with these products.